

Fast-Frame™ adjustable steel door frames

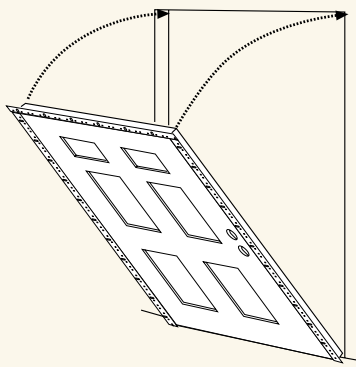

THE ULTIMATE ADJUSTABLE KERFED STEEL DOOR FRAME

FAST-FRAME's advanced design adds a new dimension of flexibility and durability to Masonite's steel entry door line. Developed and manufactured exclusively for Masonite by TIMELY®, FAST-FRAME™ features a full 1" of adjustability to accommodate almost any variation in wall construction. This easy-to-install, user-friendly, kerfed steel door frame system is applicable to a full range of residential and commercial applications - wood or steel stud construction. TIMELY's expertise in innovating and manufacturing steel door frame components is second to none. FAST-FRAME is engineered to meet the most stringent code requirements including structural, impact and 90-minute fire ratings.

SILLS

Standard Inswing
Thermally broken - 5-5/8" width
Optional extenders for larger wall sizes
Note: Not for use on outswing applications.



Handicap (ADA)

Double Slope 4-9/16" & 6-9/16" width 

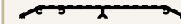

Tile Face

4-1/4" & 6-1/4" width 

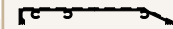

Bumper Outswing



TA-1 ADJUSTABLE T-STRIKE

1/4" of adjustment allows for ease of field installations for proper door closure

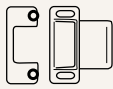

OUTER ADJUSTABLE CLOSURE

20-gauge steel
2 uprights - 1 header

CLOSURE SPAN ADJUSTMENT CHART

Wall Sizes ^A

4-1/2" - 5-1/2" = 1-7/8"
5-1/2" - 6-1/2" = 2-7/8"
6-1/2" - 7-1/2" = 3-7/8"

Wider sizes are available upon request.

WEATHERSTRIPPING

Schlegal foam-filled compression (QEBD500)
90-minute fire rating

PRIMED WHITE GALVANIZED STEEL

Galvanized 20-gauge steel provides superior corrosion resistance, matches our Masonite HD bright white doors, and is an ideal surface for painting

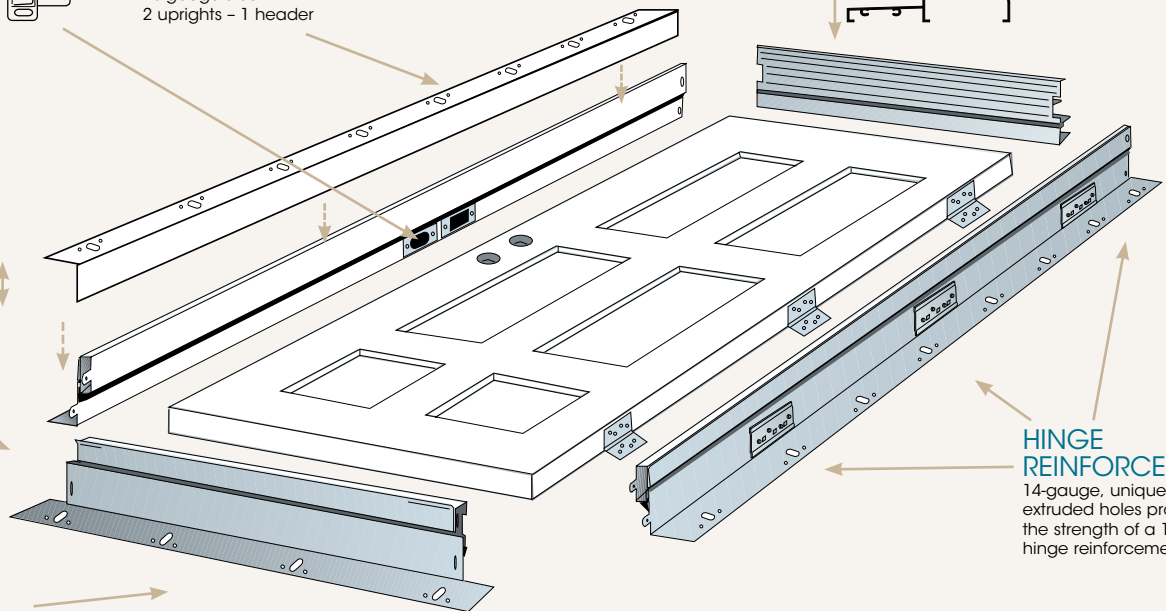



HINGE REINFORCEMENT

14-gauge, unique extruded holes provide the strength of a 12-gauge hinge reinforcement

FAST-FRAME™ Rough Openings

Prehung door sizes

	Nominal Door Size	Rough Opening Size (wood stud)
	Width x Height	Width x Height
Single door 	2'0" x 6'8"	25-1/4" x 81-5/8"
	2'6" x 6'8"	31-1/4" x 81-5/8"
	2'8" x 6'8"	33-1/4" x 81-5/8"
	2'10" x 6'8"	35-1/4" x 81-5/8"
	3'0" x 6'8"	37-1/4" x 81-5/8"
Double door 	4'0" x 6'8"	49-1/4" x 81-5/8"
	5'0" x 6'8"	61-1/4" x 81-5/8"
	5'4" x 6'8"	65-1/4" x 81-5/8"
	5'8" x 6'8"	69-1/4" x 81-5/8"
	6'0" x 6'8"	73-1/4" x 81-5/8"

*Z astragals only available in 6'8" and 8'0" heights

- Double door width is with a "Z" astragal. If using a 5/8" astragal then add 9/16" to the width
- All dimensions shown are for doors with standard inswing sill. Deduct 13/16" for bumper outswing or handicap compliant sill
- Add 4" to height for 7'0" height
- Add 16" to height for 8'0" height



Stock items are shown in **bold red** type. Non-stock items are shown in **black** type and are special order only.

CASING OPTIONS



Wood trim and brickmould can be easily applied to Fast-Frame using nails or trim head screws without the need for custom millwork.

FAST-FRAME CASINGS



- TA-8 casings enhance any commercial or residential setting.
- TA-30 casings add a special warmth for assisted living, motels, hotels, offices, apartments and homes.

It is recommended that TA-18 retainer clips be used for both casings.

APPLICATIONS

- Multi-Family ■ Assisted Living ■ Motel/Hotel
- House to Garage ■ Garage to Exterior



FIRE LABELS

Up to 90-Minute Fire Ratings available in single and double* configurations

*A "Z" astragal and flush bolt are required for double fire ratings (sold separately)

\$10.00 List Per Label

CLOSURE TEST

In a 90-minute application, the door will close and latch from 18" if the following Fast-Frame components are used:

- QEBD500 Foam-Filled Compression Weatherstripping
- Factory Sweep • Adjustable T-Strike • Factory Supplied Sills • Self Closing Hinges

Inner Frame – Price includes frame hinge, strike, head, 4-9/16" inswing sill, hardware and installation pack and 3 YC-2 hinges

Outer Frame – 2 legs and a head

To order a complete door system: Add your slab price to the inner frame and outer frame and then any options such as deadlock or hinge finish

T-strike plate kit in 26D Brushed Chrome add \$5 each

FAST-FRAME OPTIONS (FOR LOCK PREP AND HINGE OPTIONS SEE PAGE 94)

Fast-Frame adjustable steel frame pricing	Single Prehung (IN STOCK)	Double Door (SPECIAL ORDER 5-6 WEEK LEAD TIME)
6'8" TALL	2'6" - 3'0" x 6'8"	4'0" - 6'0" x 6'8"
Inner Frame	\$180	\$242
FF1 Outer Frame (4-1/2" to 5-1/2")	\$59	\$106
FF2 Outer Frame (5-1/2" to 6-1/2")	\$69	\$121
FF3 Outer Frame (6-1/2" to 7-1/2")	\$80	\$135
FF4 Outer Frame (7-1/2" to 8-1/2")	\$127	\$186
TA-8 Casing (per side)	\$69	\$76
TA-30 Casing (per side)	\$74	\$81

7'0" TALL	2'6" - 3'0" x 7'0"	4'0" - 6'0" x 7'0"
Inner Frame	\$201	\$314
FF1 Outer Frame (4-1/2" to 5-1/2")	\$83	\$129
FF2 Outer Frame (5-1/2" to 6-1/2")	\$94	\$144
FF3 Outer Frame (6-1/2" to 7-1/2")	\$105	\$160
FF4 Outer Frame (7-1/2" to 8-1/2")	\$150	\$210
TA-8 Casing (per side)	\$79	\$86
TA-30 Casing (per side)	\$84	\$90

8'0" TALL	2'6" - 3'0" x 8'0"	4'0" - 6'0" x 8'0"
Inner Frame	\$223	\$325
FF1 Outer Frame (4-1/2" to 5-1/2")	\$85	\$155
FF2 Outer Frame (5-1/2" to 6-1/2")	\$94	\$171
FF3 Outer Frame (6-1/2" to 7-1/2")	\$109	\$185
FF4 Outer Frame (7-1/2" to 8-1/2")	\$157	\$244
TA-8 Casing (per side)	\$79	\$86
TA-30 Casing (per side)	\$84	\$90

Sill option adders list prices	Single Prehung	Double Prehung
3/4" extension	\$7	\$13
2" extension	\$11	\$22
4-9/16" outswing	\$33	\$66
4-9/16" handicap	\$33	\$66
6-9/16" handicap	\$39	\$77
4-1/4" tile	\$33	\$66
6-1/4" tile	\$39	\$77

Slab list prices

Stock Doors 2'8", 2'10" and 3'0" x 6'8"	Steel Edge 6'8" (M) 90-Minute Mylar Paper Label
Flush	\$190
2 Panel Camber-top	\$196
4 Panel Rectangular	\$196
6 Panel	\$196
Special Order Doors	Steel Edge (M)
3'6" x 6'8" Flush	\$250
2'8" and 3'0" x 7'0" Flush	\$210
2'8" and 3'0" x 8'0" Flush w/ Warnock Hersey Label	\$320
2'8" and 3'0" x 8'0" 6 panel w/ Warnock Hersey Label	\$320



STRUCTURAL PERFORMANCE AND IMPACT RATING

Design pressure ratings are available for compliance with national, state and local wind load and/or missile requirements. Product tested for structural and impact performance in accordance with TAS 201, 202, and 203. Product approval available under the Florida Department of Community Affairs (FL10357). Please note: Structural and Impact performance requires use of a hurricane grade 5/8" T-astragal for double doors.